

INSTALLASJONSVEILEDNING

MOBILTELEFON SIGNALFORSTERKER

Nikrans NS-2500GDW



Frek.: 900, 1800, 2100 MHz
Dekning: 2000 m²

PREFACE

This user's manual describes the installation and maintenance of wide band consumer boosters. Please do read user manual carefully before installing and maintaining repeaters. The information in this manual is subject to change without prior notice.

1. SAFETY WARNINGS

Users must follow the principles below◇



Repeater should follow system requirements; assure good grounding and lightning protection.



The power supply voltage of repeater should meet security requirements; any operation shall be carried out only after turning off power in advance. Only the professional is authorized for the operation.



Do not dismantle machine, maintain or replace its components by yourself, because this way the equipment may be damaged and you may even get an electric shock.



Do not open the repeater, touch the module of the repeater, or open the cover of the module to touch electronic component. The components will be damaged due to electrostatic.



Please keep away from heating equipment, because the repeater dissipates heat during working. And do not cover a booster with anything that influences heat dissipation.

2. INTRODUCTION AND REASONS FOR WEAK CELLULAR SIGNALS

Mobile Signal Booster is a perfect solution for providing improvement of cellular signal reception inside a house, office, restaurant, VIP Room, apartment, building or shopping mall.

Generally cell phones cannot pick up or maintain a strong cellular signal due to one of the two following reasons:

1. **Location of the Nearest Base Station** – Base stations are used to provide broad coverage. However there are many areas in which signal strength gets reduced due to topographic peculiarities or local Governmental restrictions regarding the height or location of base stations. Rural areas generally have fewer base stations than urban regions.

2. **Natural and Man-Made Obstructions** – Signal strength can also be negatively affected by trees, hills, buildings, weather and other obstructions. You may be relatively close to a base station but still unable to make a call. This often occurs inside houses, offices and other buildings with stucco, concrete or metal walls that may block the signal.

The Signal Booster works with two antennas. An Indoor antenna communicates with your cell phone and an Outdoor antenna communicates with the base station (BS). The Outdoor antenna receives a signal from the BS and sends it through the cable to the Signal Booster, where it gets amplified and re-transmitted by the Indoor antenna throughout a building. When the Indoor antenna picks up a signal from your cellular device, the Signal Booster amplifies that signal and transmits it through the cable to the Outdoor antenna and back to the BS.

(Note: The Signal Booster will only operate if there is an adequate signal to amplify.)

3. MODEL DESCRIPTION

NS2500 GDW telefonmottaksforsterker er en ny tri-band-modell designet for å øke GSM- og 3G-signaler på store steder. Den dekker opptil 2500 m² forsterkende samtaler på 900/1800 Mhz, internett 3G på 2100 Mhz.

Telefon mottaks forsterker NS2500 GDW er en ny stammodell designet for å øke GSM- og 3G-signaler på store steder opp til **2000m² (21500 ft²)**. Enheten er passende for installasjon i store private hus, kontorer, handlingssentere, fasiliteter som ligger i underjordiske områder og lignende.

Fosterkeren øker signaler på tre frekvenser samtidig: **GSM 900 MHz og 1800 MHz og 3G 2100 MHz** som er kompatible med alle mobiloperatører i **EU**, Afrika og Asia.

Denne Triband-repeateren er ment **å forbedre dårlig signalmottak** fra forskjellige leverandører (900 + 1800MHz). Det sikrer også **stabil 3G-dataoverføring** på 2100MHz og et nytt, økende popularitet 900MHz-bånd. Triband forbedrer videre **4G LTE-internett** på 1800 MHz under forutsetning om at leverandøren din støtter 4G på denne frekvensen.

Blant fordelene ved Nikrans NS2500GDW er det:

- **Automatisk nivåkontroll** for automatisk kontroll av forsterkerforsterkningsnivå med formålet med å unngå signalforstyrrelser.
- **Automatisk forsterkningskontroll** for automatisk justering av forsterkningsnivået som videre skaper gunstige signalforsterkningsforhold.
- **Manuell gevinststyringsdrakt** for avanserte brukere som ønsker å kontrollere forsterkning manuelt.
- **Avstengingsfunksjon** for å beskytte en forster mot nedbrytninger på grunn av feil i installasjon eller egenoscillasjon.

Mottaksforsterkeren tilsvare de internasjonale kravene til sikkerhet og bruk. Alle våre forsterkere er godkjent iht **CE- og RoHS-sertifikater**.

Bestill Nikrans NS2500 GDW mobiltelefon signalforsterker, og GSM- og 3G-tilkoblinger vil bli stabile for alltid!

4. SPECIFICATION

Dekningsområde:	2000 m ²
Opplinkfrekvens:	880-915, 1710-1785, 1920-1980 MHz
Inngangsfrekvens:	935-960MHz, 1805-1880MHz, 2110 MHz
Opplinkvinning:	65 dB
Nedlinkvinning:	70 dB
Strømforsyning:	Input AC90~264V,output DC12V/3A
Energiforbruk:	0.007 kW/h
Fungerer i temperaturer på °C:	-25/+55
Fuktighet:	5 - 95 %
Størrelse (mm):	210 x 145 x 44
Forsterkerens vekt:	2.3 kg
dBm:	20 dBm

5. REPEATER SYSTEM OVERVIEW

The picture below shows how simple and fast booster installation is and how effectively it works.

A Yaggi or panel antenna (it depends on the booster model and its power), as donor/outdoor antenna, is installed at the top of the roof to pick up good mobile signals from the base station, and sends them through the cable to the booster where the signals get amplified significantly; and then the output signals are distributed throughout the area by the indoor/server antenna. Clear phone calls or high speed mobile data are immediately achieved within the area.

A repeater kit includes:

- **Outdoor Antenna** ♦
Outdoor panel or wide band Yaggi is recommended.
Function: To pick up outside signals from the base station and send them by cable to the repeater; outdoor antenna also transmits the uplink signals from the repeater back to the base station.
- **Indoor Antenna:**
It is mounted inside a building to transmit the improved signals throughout the coverage area.
- **Cables:** Coaxial cables for indoor and outdoor antennas.
- **Mountings:** Special mountings for antennas and the booster (depends on a booster model)
- Power Supply

Optionally:

- **Splitters** or couplers: when the building structure is too complicated or there is big loss due to thick walls or other reasons, splitters or couplers shall be used so that more antennas can be installed in separate zones to distribute the signals to each corner of the coverage area.
- **Additional indoor antennas:** when the building structure is too complicated



6. ANTENNAS AND CABLES SETTING UP

6.1. Outdoor antenna installation



The repeater's main function is to improve weak RF signals in an area. The formula is: $\text{Input power} + \text{Gain} = \text{Output power}$. The signal strength from an outdoor antenna directly affects the efficiency of the indoor coverage. It is very important to choose the correct outdoor antenna location in order to get the best signal.

If you don't know exactly where your operator's base station is located, go through the antenna aiming process for getting the best result. To aim the antenna correctly, follow the steps below:

1. Setup the entire booster system, including antennas and cables, and power it on.
2. A person on the roof aims the antenna in a certain direction. The other person inside waits for 1 minute and checks signal level on the phone.
3. Then rotate the antenna its 1/8th of the way around, which equals 45 degrees. The person inside does the same procedure with signal testing.
4. Repeat the process 8 times until you try all 8 directions, in every 45 degrees sector.
5. Compare the results of signal testing - the closer dB parameter to 0, the better booster performance you get.
6. Fix the antenna in the direction with better signal result.

Note! We recommend mounting the antenna on the side of the building aiming away from the building, which will reduce amount of possible obstacles. For your convenience and acceleration of the process perform the testing in pair.

- The mobile phone shall display full bar signals in location where the outdoor antenna is installed. Phone calls or data transmission shall be smooth and stable. It is recommended to test the signal 3 times in location where an outdoor antenna is to be installed. As shown from the illustration above, you should test the signals in points from A to E, and select a best place that displays full bar signals.
- Outdoor antenna installation Requirements:
Outdoor antenna should be installed on the roof of the house or in some other place where your mobile device is within coverage zone. Mobile signal should be as strong that at least three-four bars are indicated on your phone display.
Outdoor antenna should be fixed in straightly.
It is necessary to waterproof connectors of the outdoor antenna and feeder lines.
Repeater is a two-way signal amplifier. So proper isolation between outdoor antenna and indoor antenna is necessary in order to avoid self-oscillation. A perfect example of self-oscillation is when you take a MIC and a loudspeaker for example; if they are too close to each other, it could cause big noise.
If isolation can't be achieved due to limited distance, the roof of the building, walls or any other barriers can be used between antennas to increase isolation.

Installation of a panel antenna as an outdoor antenna

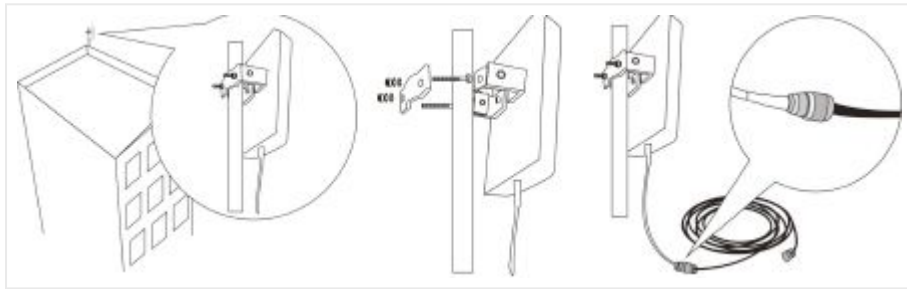

Installation of Yagi wide band antenna as an outdoor antenna

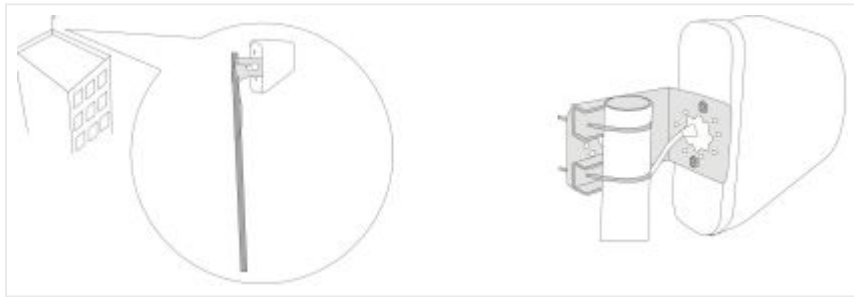

Installation of a Yaggi antenna as an outdoor antenna

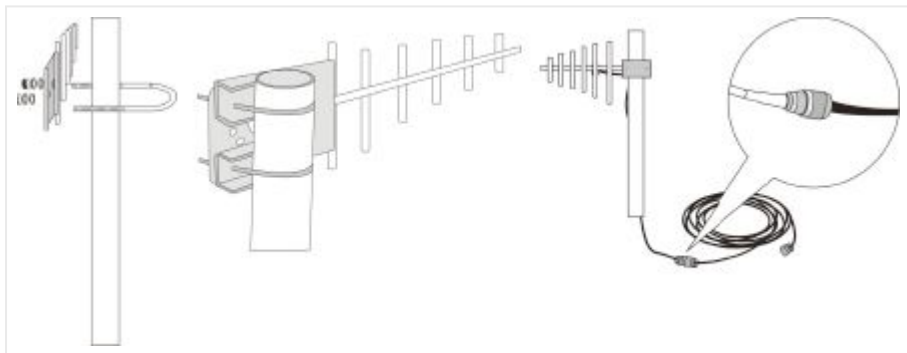

Cable layout and connector assembly

1. Keep the type, specifications, routing direction, location and curvature radius of cables in compliance with the model requirements. Place cables in correct order, bend them smoothly, and protect the surface from any damage.
2. Place RF cables separately from power cables. Take proper isolation measures if they have to be placed on the same cable racks owing to the site condition restrictions.
3. Fasten all connection parts of the whole system in correct order, from the antenna to repeater interfaces, and make sure that the electrical interfaces are well contacted. Give waterproof treatment to outdoor connection parts.
4. Take lightning protection measures for the antenna and feeder system in accordance with the system requirements. Avoid deforming the antenna feeder where grounding clips are placed, and give waterproof treatment to the feeder.

Indoor antenna installation

Correct antennas types shall be used according to the site conditions and the requirement.

1. Omni antenna (ceiling Omni or whip antenna) shall be installed in the center and radiate all directions.
2. It is better to use a directional panel antenna or Yaggi antenna when the area shape is long and narrow (corridors, long row of houses in two sides, tunnels or elevators or rural open space).

Requirements to indoor antenna installation:

- indoor antenna should be 5 meter distance from an outdoor antenna
- indoor antenna should be at least 2 meters above the ground
- indoor antenna should be fixed vertically with the ground.

7. REPEATER INSTALLATION

7.1 Installation requirements

7.1.1 Installation Location Requirements

1. The repeater shall be installed indoor in a cool, dry and ventilated room without erosive gas or smoke, or on a cool and ventilated wall to ensure excellent heat dissipation.
2. Installation height should be sufficient for RF cable wiring, heat dissipation and maintenance.
3. Independent and stable power supply is necessary.

7.1.2 Power requirement

Generally AC 100~264V AC / 50±5Hz power supply is required.

7.2. Installation Steps

7.2.1. Installation schemes

Installation with 1 indoor antenna

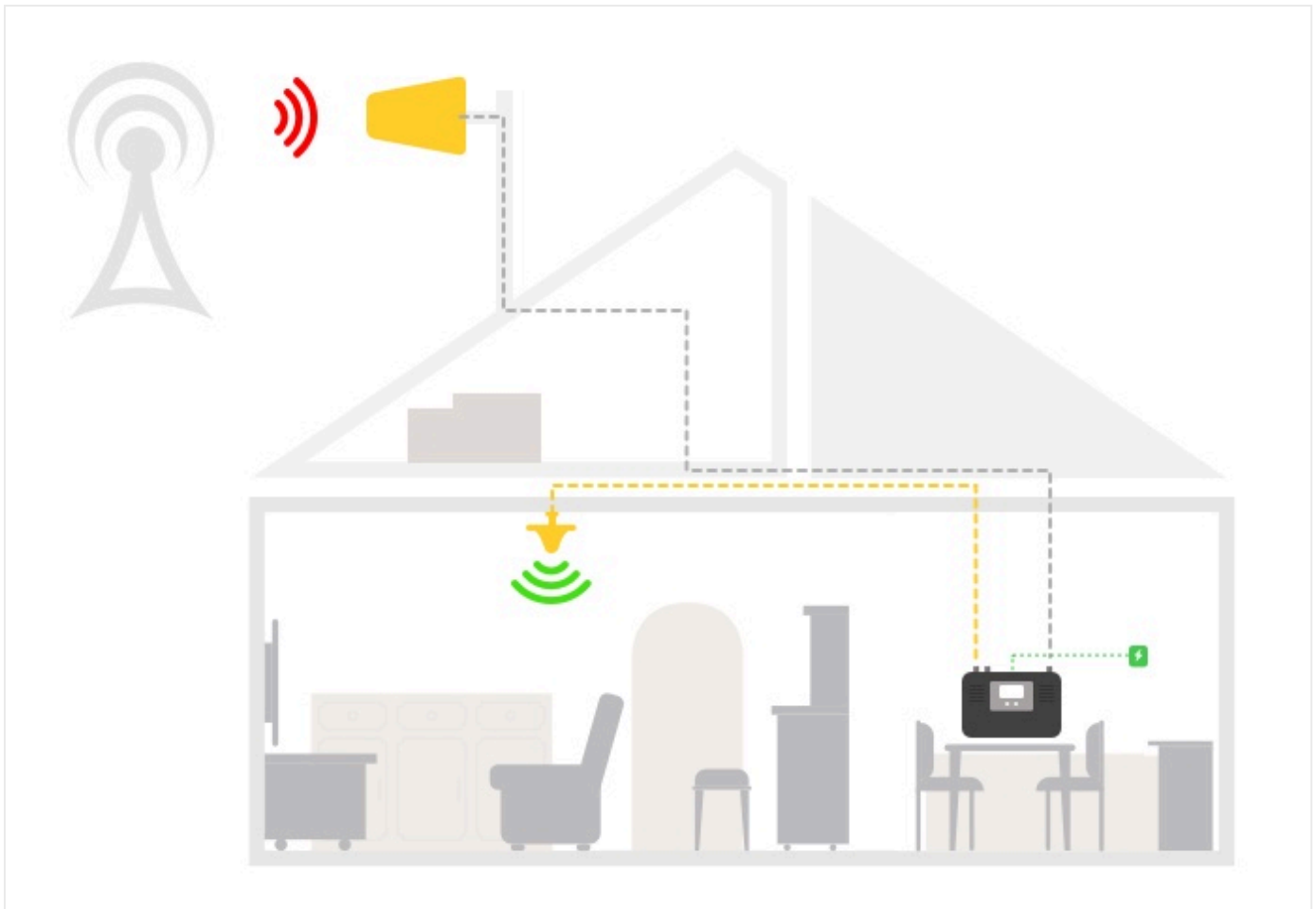

INSTALLATION STEPS

1. Find an appropriate position for an outdoor antenna. (see *the requirements in 6.1. sect.*)
2. Plug in the outdoor antenna to the mobile booster from BS side and fasten tightly.
3. Plug in the indoor antenna to the mobile booster from MS side and fasten tightly.
4. Connect the signal booster to the Power Supply.

!Some models have an inbuilt Power Supply. Please, examine the manual applied to your model, if your signal repeater kit doesn't include separate Power Supply, skip this step!

If the light indicator on the booster turns on it means the installation has been implemented correctly.

NOTE: Switch on the signal booster only after you connect outdoor and indoor antennas in the proper way!

5. Test the signal of your mobile telephone – a maximum quantity of bars should be indicated on the display of your phone in each corner of the location within booster coverage zone. In case the mobile signal is still instable try to change the position of the outdoor antenna for more proper one.

Important notes for installation:

1. Cables from outdoor antenna should not be wound and be placed as straight as possible in order not to create any hindrance for signal reception and its transmission.
2. Cables should be shortened to the acceptable maximum so that not to waste or decrease mobile signal coverage range.
3. In order to prevent water from coming into the mobile phone booster through the cable make a loop in it.
4. Keep the outdoor antenna as far as possible from frequency aerials, high voltage cables, metal nets or transformers.
5. Don't put the antennas (outdoor and indoor) too close to each other. Recommended distance is 10-20 m. Be sure to point them to the opposite directions to avoid the risks of malfunctions such as self-oscillation or interference. It's also recommended that they are not placed in direct vision to each other (use metallic obstacles, wall, ceiling, slab, etc).
6. Plug the power supply into the Signal Booster input (carefully, to avoid damaging the center pin) and then into a wall outlet.

Note: *It is recommended to plug all AC power supplies for home electronics into a Surge Protector Power Strip.*

7. Switch the booster on only after having positioned the antennas correctly, according to the instructions above.
8. Using multiple Signal Boosters in one installation could cause interference to the base station (except for the In-Line Signal Boosters).



7.2.2 Repeater's ports description



1. Outdoor port: connected with the outdoor antenna by cable
2. Indoor port: connected with indoor antenna directly or by cable
3. DC IN: connected with power supply.

7.2.3 Accessories selection

Choosing accessories pay attention to the two characteristics - frequency and impedance. All accessories shall support the repeater's frequencies. For example, if the repeater's frequency is GSM900, all the accessories must support the GSM900 frequency.

7.3. Repeater Settings

7.3.1. Indicator Light Instructions



Repeater Features & Settings

The Three Band repeater is a newly designed device with intelligent functions

The repeater possesses all the features of a consumer electronic device helping to operate it via LCD touch screen on the front panel. Also it has many intelligent functions such as antenna isolation detection, input/output signal strength indication and a "smart" function.

See the detailed description below.

Three band repeater display and operation interface

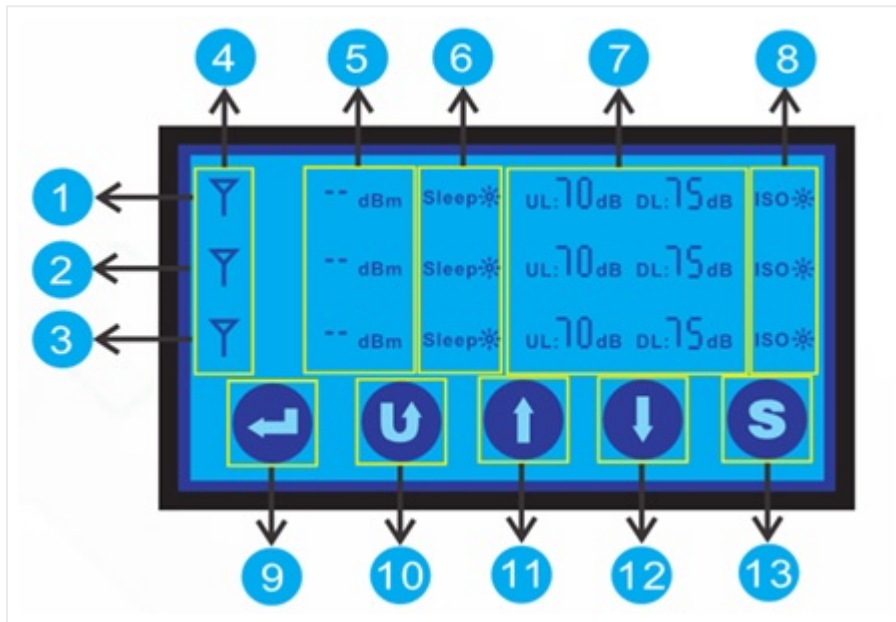

1. **The 1st line** shows the working status of Band 1 - **EGSM 900 MHz**.
2. **The 2nd line** shows the working status of Band 2 - **DCS 1800MHz**
3. **The 3rd line** shows the working status of Band 3 - **WCDMA 2100MHz**
4. 5 bars appearing next to the output signal strength indicator signify the maximum output power of the repeater. **One signal bar is 5 dB.**
5. The input signal strength measured in **dBm**.
6. **Uplink Sleep Mode.** The uplink of the repeater is in standby mode when there is no call or data transmission. It will be activated immediately when a call or a data exchange session are initiated.
7. **UL and DL maximum gain.**
8. **Antenna Isolation Detection.** After switching on the repeater for the first time, it will automatically detect the oscillation between the outdoor and indoor antennas.



9. Press **“Enter”** to select or confirm the settings.



10. **Back** to the previous page or to cancel the settings.



11. **Increase** the gain.



12. **Decrease** the gain.



13. **Smart** The repeater can set the gain automatically to prevent the alarm.

LED indicator status and definition

In order to maintain required output signal levels, this repeater has in-built signal oscillation detection circuit to adjust the gain automatically so as to avoid interference to the operators' cellular network.

When the **“Smart”** function is enabled, the repeater sets up the suitable gain automatically thus not causing any interference to the mobile network.

The repeater also has **Manual Gain Control (MGC)** feature that enables users/ engineers to reduce the gain of the repeater manually with the help of a touch screen, if any oscillation is detected.

In this case, the **“Smart”** function must be disabled. The repeater LED indicators will change their color in case of a too strong input signal or oscillation detected. Thus, the **Alarm LED** located on the front panel will turn from green to orange or red (depending on the strength of the input signal).

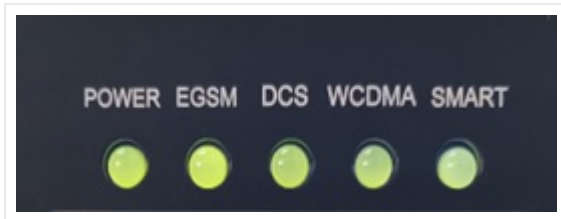

After switching on the repeater, check first the POWER and ALARM LEDs.

Status and definition of the **POWER** indicator:





Status	Definition
Green	Normal
Off	DC power problem

Status and definition of the **ALARM** indicator (**EGSM, DCS, WCDMA**):

Status	ALARM
Green	It is working in linearity
	Note: Input signals may be not enough, please pay attention to the readings displayed by the device. Do not do anything if it is good; otherwise please adjust the repeater system to get better source signal.
Green Flickering	It is working with slight oscillation.
	AGC is activated at 1~10dB.
Orange Flickering	It is working with medium oscillation.
	AGC is activated at 11~20dB.
Red Flickering	It is working with high oscillation.
	AGC is activated at 21~30dB, and the repeater will shut off after 5 seconds of the LED flickering red.

The repeater also has a Network Safe / MUTE feature that automatically shuts off the repeater in order not to interfere with the operators' cellular network. Users shall make sure that the LED indicators remain green at all times for optimum system performance.

Manual Gain Control (MGC)

Press “  ” icon until you get to the uplink gain settings (the uplink gain value is flickering), then press “  ” to decrease the gain as required or press “  ” to increase the gain, if the setting is not proper. Please press “  ” again to confirm the set value.

Please proceed with the same steps for setting the downlink gain.

Smart function

The Smart function means that the repeater could set the gain automatically. Users should press  to turn ON or turn OFF this function.

*Remark: When the “**Smart**” function is ON, the users will not able to set the gain manually. If you need to set the gain manually, please turn OFF the “**Smart**” function, and then follow the instructions for MGC setting.*

Questions & Solutions

What signal level in dBm is optimal for the correct booster functioning?

For the optimal functioning of the booster, the BS (input) readings should be between - 65 and 50 dBm. The MS (output power) readings must be between +05 and +15 dBm. Device Gain must be 65/65 dB. If the BS is lower than - 65dBm, the coverage will be smaller. However, the device can work normally. If the BS is too weak, it'll be necessary to adjust the position of the outdoor antenna by raising it as high as possible (on a pole on the rooftop) and pointing it towards the provider's nearest base station. If the BS is higher than - 50 dBm, the device will have a self-excitation issue. In those conditions, the output signal will drop during communications. If the two antennas are placed very close to each other, it will evoke self-excitation. To fix the problem, you would need to place the outdoor antenna at the largest possible distance from the indoor antenna.

7.4. System Test

7.4.1. Check whether the coverage is good

1. Take a test with a mobile phone or a data card (engineering mobile phone is preferred).

To test signal level with a cell phone, make use of its engineering mode (Field Test Mode), which is an application available in free access or a phone mode requiring no extra setups. On most used mobile OS (operating systems) the test mode can be started as follows:

- iOS. Type *3001#12345#* and hit Call
- Android. Type *##*197328640##* to activate
- Windows. Type ##3282# and start.
- Blackberry. Press TOOLS, SETTINGS, STATUS or OPTIONS, STATUS.

Note! To get parameters for 2G, 3G and LTE, disable WiFi. In case you cannot find Field Test Mode on your cell phone, use bars on the screen of your mobile phone to evaluate the change.

If the signals in most areas have not been improved, please check recommendations below again:
 - Weak input signal leads to low output power. To increase input signal power level, change the direction of the outdoor antenna or its installation position or replace it for an antenna with higher gain.

- Check whether it is necessary to use additional indoor antennas as barriers block signal penetration; also check whether the repeater's power is enough; please install extra indoor antennas or replace the repeater for another model with higher power level.

2. If the signals in small parts of the area have not been improved, please check the following:

- Check whether the indoor antenna is installed correctly or not; you may try to change the antenna location to improve coverage.

- Check if it is necessary to adjust the direction of the indoor antenna.

- Check whether it is necessary to add one or more antennas to enhance the coverage in special areas.

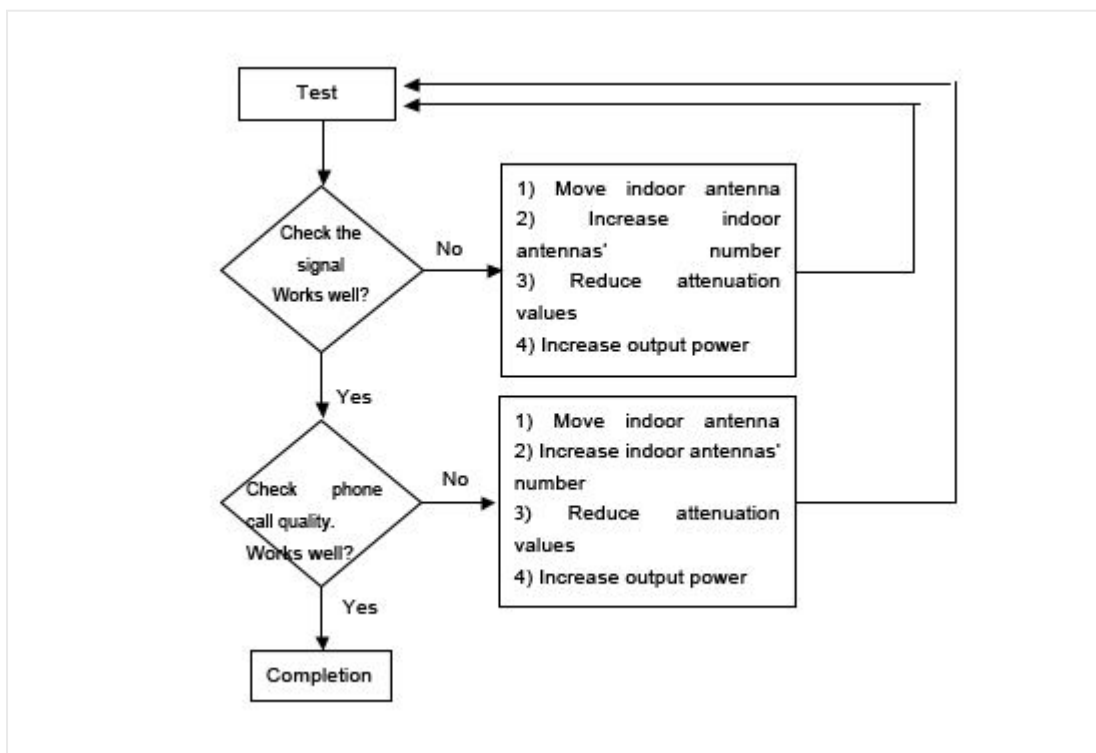

For maximum precision in signal level testing, switch your cell phone into Field Test Mode and see dB parameter. The closer dB signal level to 0, the better cell phone reception you'll get.

- -105 to -100 = Bad/drop call
- -99 to -90 = Getting bad/signal may break up
- -89 to -80 = OK/shouldn't have problems, but maybe
- -79 to -65 = Good
- Over -65 = Excellent

Your task is to get at least -79dB signal to ensure reliable communication and strong signal inside the building.

Remark:

- **Reduce attenuation values** * — by ensuring the isolation level
- **Increase output power** * — recommended ways: to adjust outdoor antenna direction/location, or replace it to an antenna with higher gain to increase input signal strength.

7.4.2 Repeater can not communicate in Power-ON status

1. The power is on but there is a signal fluctuation or a flash signal. The phone call cannot be made/received.

It shall be caused by the insufficient isolation between outdoor and indoor antennas.

Please take the following measures:

- Firstly check whether the alarm LED lights. The light may indicate the isolation is insufficient.
- Secondly adjust the antennas' directions or locations or enlarge distance between them.
- Thirdly reduce the repeater's gain by ATT DIP if the above listed methods don't work.

The following measures can also be helpful:

- Use the roof of the building to enlarge isolation (Please try to place the outdoor antenna and indoor antenna on different floors).
- Use some obstacles (Such as walls).

2. The repeater's power is on but the phone cannot get connected to the network and still can not communicate.

Reason 1: There are loose or wrong connections in the repeater system.

Solution: Please try to fasten the connections between different parts of the system.

Reason 2: The signals received by outdoor antenna of other operators nearby are too strong. (For example, the other operators' signals are 10 dB stronger than the needed signals.)

Solution 1: Change the direction of the outdoor antenna or its installation position, so that the gap of signal strength is reduced between operators.

Solution 2: Use barriers (like buildings and walls) to block signals from other operators.

8. FAQ

1. Will booster increase the RF radiation?

No, it will decrease instead.

Every cell phone irradiates heavily being in zones with poor mobile signal as a cell phone is constantly in searching mode. The danger is your cell phone is about 2cm to your body, which makes its usage rather harmful. And when a booster is installed, it improves the mobile signals in the coverage, and your cell phone stops irradiating strongly, thus it will reduce the RF radiation of the mobile phone tremendously.

The maximum power level of booster is 0.01W, and it decreases to be maximum 0.001W when reaching indoor antenna. And since the indoor antenna is installed over the ceiling or onto the wall, there is usually more than 3 meter away from the human body, 3meter away means at least 40dB propagation loss, or 10000 times less, 0.0000001W, and therefore it is too weak to influence human bodies though it is still a very good signal for mobile phones.

2. If the power indicator is off after installing the repeater, what should I do?

Check if the repeater's power supply works normally or not.

3. If repeater's power supply is normal, ALM light is on or flashing all the time, what should I do?

Firstly, check whether all connectors are connected well or not. If it is all right, please, adjust the direction of the outdoor and indoor antenna. Make sure the horizontal distance is 75 feet or more, the vertical distance is 20 feet or more.

4. If the repeater and power supply are installed correctly, why the signal is still bad?

1. According to the steps above, verify if all the cables and connectors are connected correctly or not and correct the connections if necessary.
2. If connections are correct, please, adjust the direction of the outdoor antenna, point it towards BTS antenna, and make sure it can accept the strongest signal.

5. After installing the repeater, the signal is good, but the connection is slow or intermittent, or I cannot hear clearly the other side?

1. Please, check the indoor antenna position, and whether the cables and connectors are connected correctly or not.
2. Adjust the indoor antenna direction and make sure it can easily receive a cell phone signal.

